

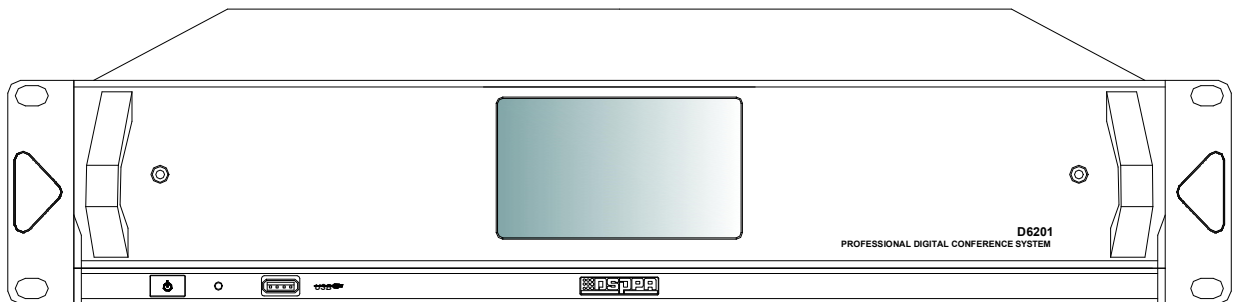

Conference System

Intelligent Conference Host

D6201



User's Manual

Welcome to use DSPPA public address system. For the better use of this product, please read this instruction carefully prior to use.

Guangzhou DSPPA Audio Co., Ltd
<http://www.dsppatech.com>

此页留空供用户记事

Introduction

This manual is used on the conference control host D6201. The manual includes the system introduction, the precautions for use, the system connection instructions, and the product instructions for the conference control host D6201. Users should carefully read this manual before connecting and installing and using it, and follow the instructions in the manual. .



Instructions marked with this mark on the rear panel of the machine are all matters that must be taken care of. Please be sure to use or operate them in accordance with these instructions.

Please keep this manual in a safe place for future use.

D—V0.6

Facture 2018-5-23

⚠ Caution











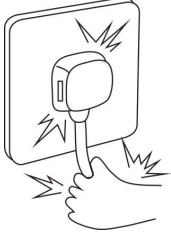

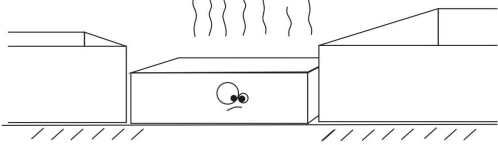

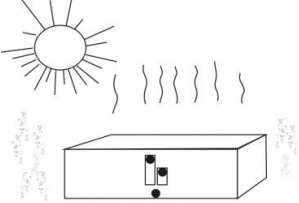

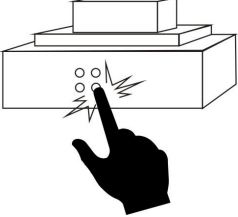
To assure the finest performance, please use or operate the product in accordance with corresponding instructions.

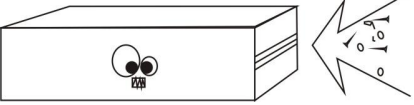

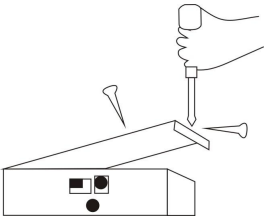
This symbol indicates "forbidden content"

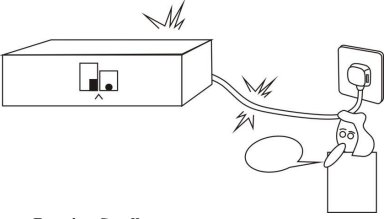

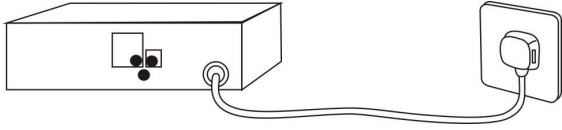
This symbol indicates "compulsory content"

<p>■ Please make sure that the power wire is NOT damaged. Do NOT unplug the equipment by pulling the power wire; otherwise it may cause electric shock, short circuit or fire.</p>  	<p>■ When the equipment is in use, DO NOT block the air outlet which should be kept clear, in order to avoid overheat.</p>  
<p>■ Do NOT store this equipment in any place with heavy dust or vibration, or where it is extremely cold or hot.</p>  	<p>■ Please do NOT place any heavy article on this equipment. Please operate switches, buttons or external audio source carefully.</p>  
<p>■ Please prevent foreign matters (such as paper, metal etc.) entering the equipment through the gaps or opening, in such cases, please cut off the power supply immediately.</p>  	<p>■ Do NOT attempt to remove any internal component from the equipment, or modify the equipment in whatever manner.</p>  
<p>■ In case that sound is suddenly off or there is abnormal odor or smoke, please unplug the equipment from the power socket to avoid potential electric shock, fire or other accident. The equipment should be inspected by professional personnel.</p>  <p>Burning Smell</p> 	<p>■ If the equipment is not in use for a long period, please unplug it from the AC power socket to realize zero energy consumption.</p>  

Content

1. PRODUCT INSTRUCTION	1
1.1 EQUIPMENT INTRODUCTION	1
1.2 FEATURES	1
<u>2. APPEARANCE INTRODUCTION</u>	2
2.1 FRONT PANEL	2
2.2 REAR PANEL	2
3. CONNECTION INTRODUCTION	4
3.1 SYSTEM CONNECTION	4
4. OPERATION GUIDE	5
4.1 CONFIGURATION	5
4.1.1 BOOT DEVICE	5
4.1.2 PLAY MUSIC.....	5
4.1.3 NUMBER OF SPEECH.....	5
4.1.4 VIDEO FOLLOW ON-OFF	5
4.1.5 CAMERA SELECT	6
4.1.6 MEETING MODE.....	6
4.1.7 SOUND EFFECT CONTROL	7
4.1.8 RECORD CONTROL	8
4.2 SYSTEM CONFIGURATION	8
4.2.1 NETWORK SETTING	9
4.2.2 CAMERA TRACKING POSITION SETTING	9
4.2.3 MICROPHONE UNIT DETECTION	10
4.2.4 CONFERENCE MICROPHONE ID SETTING	11
4.2.5 CONFERENCE MICROPHONE SETTING	12
4.2.6 SET SPEAK TIME.....	14
4.2.7 CHIME SET	14
4.2.8 SYSTEM TIME SETTING	14
4.2.9 DISPLAY SETTING	15
4.3 EXTENDED HOST ADDRESS ENCODING SETTING	17
4.4 HOST FUSE HANDLING METHOD	19
NOTICE FOR USE	21
PACKING LIST	21
PERFORMANCE	22

1. Product Instruction

1.1 Equipment Introduction

The D6201 is a digital conference system host that integrates advanced camera management and control functions such as automatic camera tracking, 4.3-inch True Color touch screen control, and intuitive graphical interface display. The digital conference system host is the core device of the entire conference system. It supplies power to the connected conference microphone units. It can realize conference control, unit setting, electronic voting, camera tracking, audio input and output functions, and can seamlessly dock with the control system. It's suitable for all kinds of large and small meeting events.

1.2 Features

- Conform to IEC 60914 international standard
- The conference host can connect to 128 conference Mic, can extend to 4096 conference Mic via extender 8-pin conference cable connection, support cascaded connection
- FIFO, NORMAL, VOICE, FREE, APPL five conference modes
- Support simultaneous speakers limit setting of 1/2/3/4/5/6
- Support management of Voting and Speech Limit etc.
- 4.3" TFT touch screen, friendly graphical interface, easy to use
- Support Chinese/English system languages, other languages can be customized
- Support VIP Mic setting (up to 30), VIP Mic can speak freely in all the 5 conference modes
- Built-in DSP sound processor, support low-cut, frequency-shift and equalizer control
- Support conference recording, manually or automatically
- With Mic detection function, manually or automatically
- Support speech timing function, can set up speech time limit and reminder
- Support video tracking, with 6 HDMI in and 1 HDMI out, 6 BNC in and 1 BNC out
- With RS232 interface to link with central control system, with RS422 interface to control 6 cameras
- 8-pin female interfaces: 1 for Interpretation Host, 1 for extender, 3 for conference Mic
- RCA interfaces: 2 AUX input, 2 AUX output, 2 Alarm input with override function
- XLR interfaces: 2 AUX output to amplification system
- +5V Alarm trigger interface: interact with the 2 Alarm RCA input
- RJ45 interface: based on TCP/IP protocol, support computer remote control
- Support Android pad remote control
- The shell is made of all-metal materials. The connection between the circuit and the shell is enhanced with the ground wire. It has a contact type 4kV and an air-type 8kV antistatic capability.
- High-end design, 2U standard chassis, can be installed in a 19" standard cabinet.

2. Appearance Introduction

2.1 Front panel

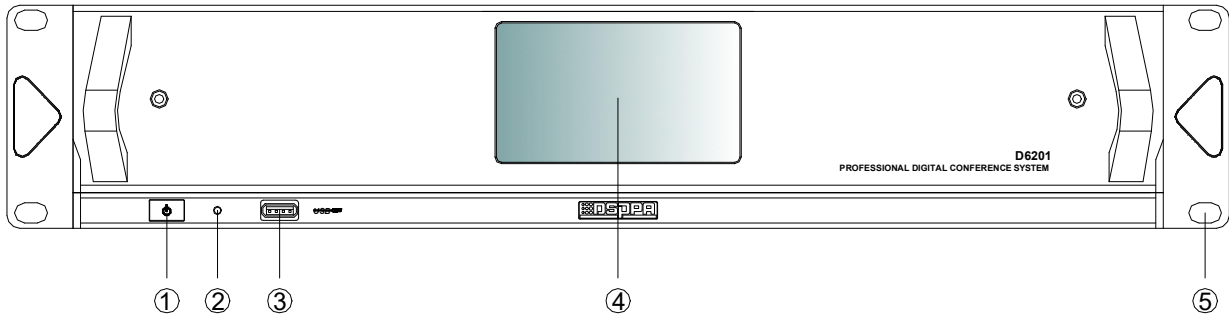

Functions on front panel of the controller:

1. Power switch (POWER)

- Power is on when the button is pushed down and is off when the button is ejected.

2. Power indicating light (ON)

- The indicating light will be on, when the system is powered on, and it is off when the system is powered off.

3. USB port (USB)

- For connection of USB flash disks during the recording process;
- A mouse with USB port may be connected to operate the system.

4. LCD touch screen display

- For display of function icons and menus in the operation process; touch screen is used in configuration.

5. Screw holes for installation in cabinet

2.2 Rear panel

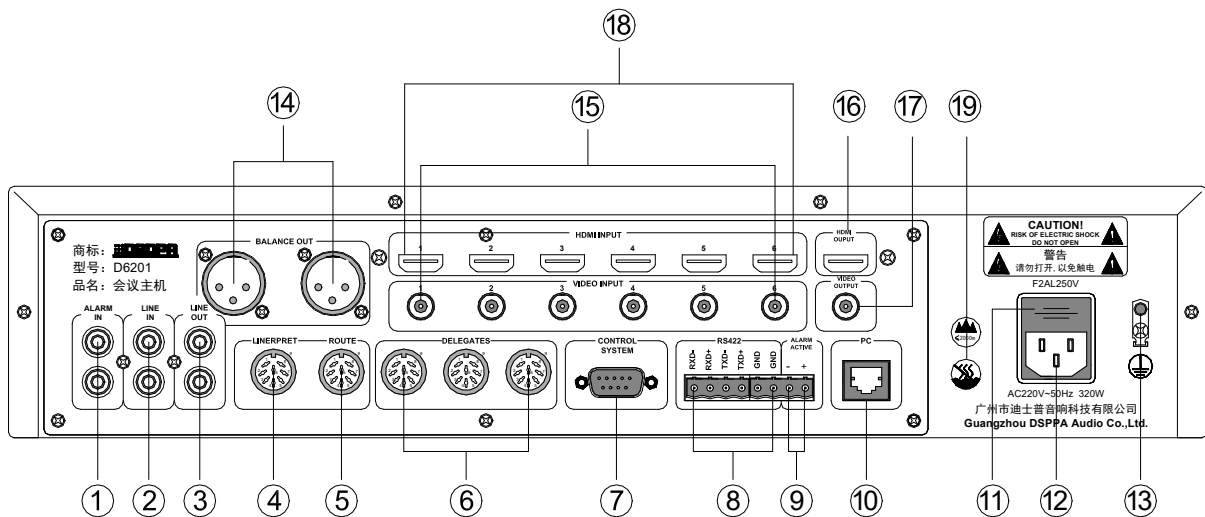

Functions on rear panel of the controller:**1. Warning audio signal input port (ALARM IN)**

- It is used for connection to warning signals from the fire control center and is interlocked to the warning triggering signal as mentioned in ⑨.

2. Line audio signal input port (LINE IN)

- It is for connection of sound source or sound console equipment to provide line audio signal to this system.

3. Mix output of audio signal (LINE OUT)

- It is for connection of amplifiers, and the output signal includes line audio signals, warning signals and microphone signals.

4. Port for connection of interpreter controller to the system (INTERPRET)**5. Extension port (ROUTE)**

- It is used to connect the conference controller and extension controllers and to transmit audio signals and communication signals.

6. Conference unit output port (3-way output, DELEGATES1-3)

- The three ports allows connection of up to 128 conference units.

7. Port for central control system (CONTROL SYSTEM)

- It is used to connect the system to a smart central control system, to realize centralized control over the conference system by far infrared.

8. Camera control port (RS422)

- It is used for connection of control signals of 4 cameras, which are connected in serial manner.

9. Fire alarm interlocking and activation port (ALARM ACTIVE)

- The system adopts +5V voltage to trigger the alarm interlocking, in which "Alarm" will be displayed on the screen of all conference units and the microphones of all conference units will be deactivated.
- When the +5V voltage on this port is off, the system will automatically return to the working status before such alarm.

10. Ethernet port (PC)

- The conference can realize remote control via TCP/IP network;
- When the system is connected to a WIFI network, it allows wireless conference control via a tablet PC.

11. Fuse in power supply of the system

- F2AL250V fuse socket;
- If the fuse is blown, please replace it with a fuse of the same specification;
- If the fuse is blown, it indicates equipment fault, so please replace the fuse after such fault has been eliminated;
- See description on Page 30 for procedures of replacing the fuse.

12. Power input

- AC220V/50Hz/320W power input.

13. Grounding connection

- It is used to connect the conference controller to the ground, so as to avoid electric shock or equipment damages caused by electric leakage.

14. Mix output of audio signals (Cannon balance output socket)

- This port is connected in parallel to output port as mentioned in ③ (LINE OUT), and is a balance output socket. The signals on the three pins are defined as below:

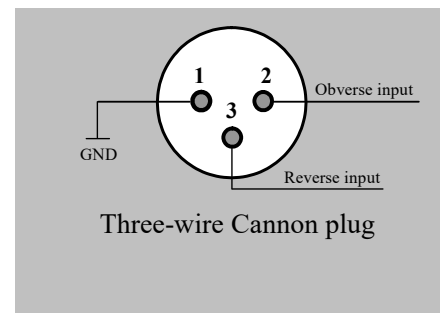
**15. 6 common cameras connection ports**

- Each port allows connection to one camera;
- All 6 cameras connected to this system must be of the same brand;
- Cameras are connected by coaxial cable.

16. HD video output interface

- Connect the projector and other video equipment, Input the camera content to the big screen

17. Common Video output port

- The port is used for connection to projectors or other video equipment, with which the content captured by cameras will be output to a large

screen.

18. 6 HD camera connection port

- Each port allows connection to one camera;
- All 6 cameras connected to this system must be of the same brand;

- Cameras are connected by coaxial cable.
19. This label means "applies only to areas under 2000 meters above sea level and safe use in non-tropical climate conditions."

3. Connection

3.1 System connection

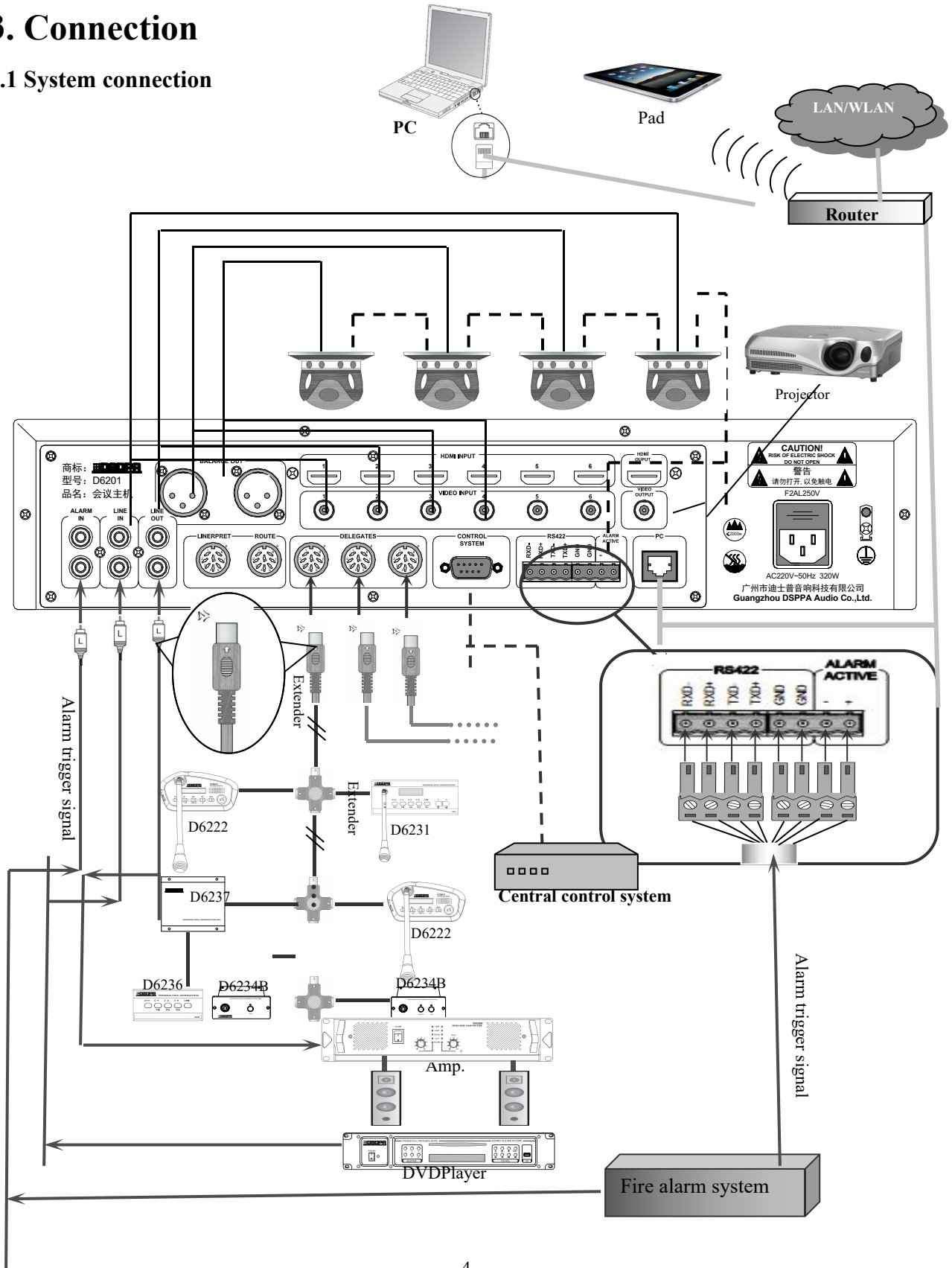

4. Operation Guide

4.1 Configuration

After all the installation and connection of the system is completed, the various functions need to be set for the conference control host, and all settings must be completed before the meeting starts.

4.1.1 Boot device

Press the power switch (the blue indicating light will be on), and the equipment will start its operating system and then start the conference control software. After the system is started, the conference system will be initialized, which will take some time. After the initialization, the system will show the main interface (start interface).



Main functions displayed on the main interface, excluding system time displayed on the top, include:

- "Number of units connected to the system"
- "Speech settings"
- "Camera tracking"
- "Camera selection"
- "Conference mode"
- "EQ Control"
- "Recording operation"
- "System settings"

Users can access the corresponding operating interface by touching these icons on the touch screen.

4.1.2 Play Music

Touch the "song play" icon on the main interface to enter the song playback setting interface (the first identification of U disk needs 30s-2min, depending on the U disk memory size, please wait patiently). Before the song is played, you must insert the USB disk that has been recorded into the song as the sound source. Song playback and recording cannot be performed at the same time. The interface is as shown below:

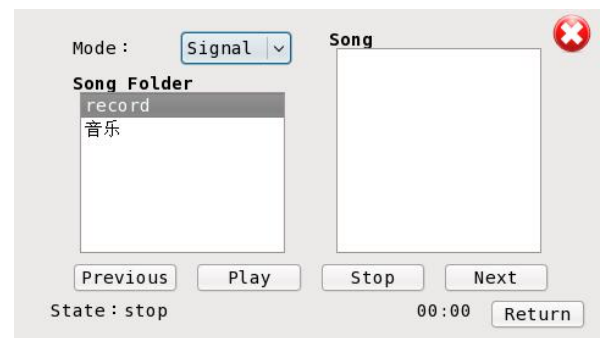

4.1.3 Number of speech

The limit of the number of speech set in this item is valid in the non-fully open conference mode (FREE). Users can view the number of active speech by touching the icon of "Speech" on the main interface, and enter the configuration interface of "Allow Speak Number". The interface is shown below:

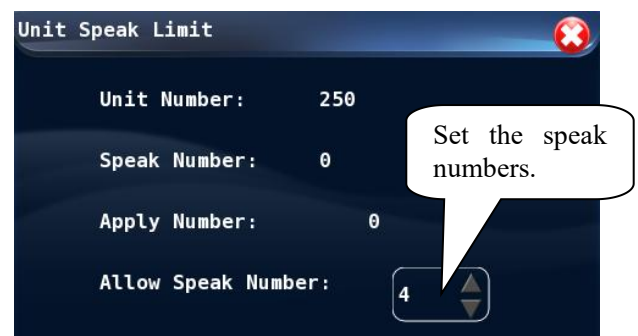

The interface indicates the number of currently active speeches, number of speech application and the maximum speech allowed, of which the maximum speech allowed may be modified by pressing the small arrows in the value box:

- 1) Touch the UP arrow to increase such value by 1;
- 2) Touch the DOWN arrow to decrease such value by 1;
- 3) The maximum active speeches is 6;
- 4) After configuration and viewing operations are completed, touch the  icon to close the unit limit interface and return to the main interface.

4.1.4 Video follow on-off

On the main interface, touch the "Video follow on-off" icon to enter the configuration interface of

camera tracking function. As shown below, the camera tracking function may be enabled or disabled on this interface. Touch the options, and if the icon before the option is green as shown below, it means that the camera tracking function has been set to the selected status. Firstly, set the status at "video follow off", and then set the camera to a



preset point (there can be 30 preset points) in the setting interface to locate and save it, and finally set the state here as the video follow on state, so that the camera preset point can be automatically tracked. It can also be controlled by PC software (see the PC software control description section for specific operations) or by the central control.

4.1.5 Camera select

The camera may be selected on conditions that the camera tracking function is off, otherwise users will not be able to select the desired camera.

On the main interface, touch the icon of "Camera Selection" to access the manual camera selection interface. The interface is as shown below:



The operable functions on the interface are as following:

1) Camera selection: In this system, 6 BNC cameras and 6 HDMI cameras can be connected. Only one of them can be selected for operation. In this operation, one of the cameras is selected (for example, camera 1 is selected), and other cameras are mainly configured with the camera. If the camera is changed (for example, camera 2 is selected), the camera needs to be reselected. The camera is set up, including the

"camera tracking switch" setting and the "camera tracking positioning" setting. When selecting a camera, touch the icon in front of one of the cameras so that the icon is displayed in green to indicate it is selected. 2) Camera naming: On the "Camera Selection" interface, the user may touch the "Camera Naming" icon to access the operation interface to name the camera. On this interface, the user may name the six cameras. The default names are as follows before such cameras are named. The user does not have to name the cameras unless he/she has special needs.



Procedures to name a camera:

- On the interface as shown above, touch the "Modify" button after the camera to be renamed, then a keyboard will show;
- Enter the new name of such camera and touch the "Ent" button to confirm and quit the keyboard;
- After the operation completes, touch the on the upper right to exit the interface and return to the upper interface.

4.1.6 Meeting mode

On the main interface, touch the "Conference mode" icon to enter the configuration interface of conference mode, which is as shown below:

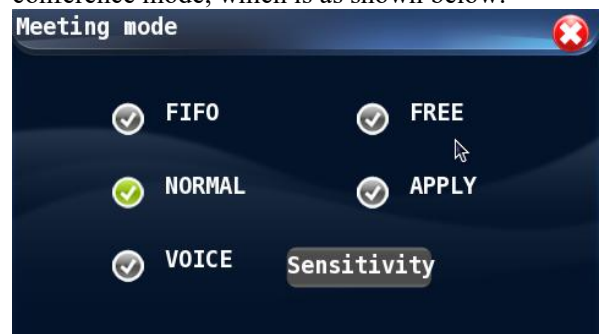

There are total 5 meeting mode as following:

- “FIFO”
- “NORMAL”

“FREE”

“APPLY”

“VOICE”

- a) FIFO mode means first-in-first-out mode. When the unit is opened to reach the set quantity, the next unit will turn off the first unit that is turned on. The total number of ordinary unit + VIP units can be up to 10 in total.
- b) NORMAL mode is the queuing mode. When the unit opens and reaches the set quantity, the unit that was first queued after the previous unit was turned off is automatically turned on, and the total number of ordinary unit + VIP units can be up to 10.
- c) FREE is free mode, supports 20 units to speak at the same time. When the number reaches 20, the subsequently opened unit enters the queue for waiting. If the VIP in the unit is queued, the VIP unit is opened first.
- d) APPLY is the application for speaking mode. The representative unit must apply for the approval of the chairman unit and open the application unit to speak. If there is no application for the VIP unit, the total number of ordinary unit + VIP units can be up to 10.
- e) VOICE is the sound control mode. It needs to set the voice control sensitivity firstly. When speaking, it will be close to the unit's microphone head and it will automatically open the unit. If there is no speech within 1 minute, the unit microphone will be automatically turned off.
 - o1 If the number of normal cells is first turned on to the set number, the total number of ordinary cells + VIP cells can be up to 10.
 - o2 If the VIP unit turns on the quantity to the set quantity first, and then open the normal unit, it cannot be turned on.

On the interface, the user can select a mode for the conference system.

1) Touch the desired conference mode to select (for example, touch NORMAL to select the NORMAL mode), the conference is selected when the icon before such conference mode is in green color.

2) If "VOICE" mode is selected as the conference mode, then the user needs to set up the sensitivity of the microphones on conference units. The procedures for setting up the sensitivity as follows:

When the icon before "VOICE" mode is in green color, touch the "Sensitivity" button after it will call the sensitivity setting interface.

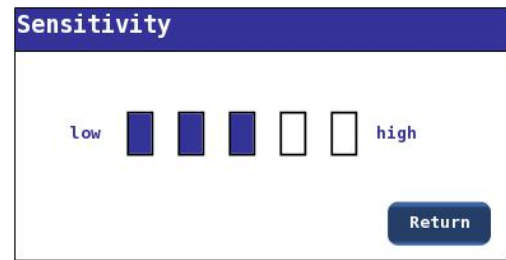

On such interface, touch the boxes which indicates the sensitivity and the boxes becomes blue, it means that the adjustment has completed.

After the configuration is complete, touch the "Return" button to exit the sensitivity configuration interface.

4.1.7 Sound effect

On the main interface, touch the "EQ" icon to enter the EQ interface, which is as shown below:



On the interface, the user can control the AUX volume, main volume, low cut, frequency shifter and equalizer setting.

- 1) AUX volume: It is used to adjust the volume of secondary audio input.
- 2) Main volume: It is used to adjust the volume of secondary output, alarm output and the volume of all conference units.
- 3) Low cut: With this option, the user may decide if the low frequency under 801Hz will be cut or not. If this option is selected, (the icon before the option is green) the low cut function will be activated, otherwise, it will be in active. If the low cut function is required, the option must be properly set up before the conference. The low cut function may also be configured on the PC control software.
- 4) Equalizer: This setting is to choose whether to use the equalizer function. There are 14 graphic equalizers in the system. There are multiple equalization modes. You can manually adjust

the balance and save the manually adjusted equalization mode for later recall. If the equalizer function is selected here, you can touch the "Settings" button behind it to enter the equalizer setting interface.



As shown in the picture, the 14 band graphic equalizer allows manual adjustment. Users may save the current value as mode 1 to mode 6.

- Users need to touch the mode button before making any adjustment to the equalizer (for example, "mode 1 is selected").
- After the adjustment is completed, touch the "Save mode" button to save the equalizer values to "mode 1", so in the future, the user may touch the "mode 1" button to call the equalizer values.

4.1.8 Record control

On the main interface, touch the "Recorder" button to enter the recorder operation interface. The conference system can realize conference recording, and the audio file recorded may be saved on a USB flash disk. Before the recording is started, plug a USB flash disk to the front panel of the conference controller, otherwise the recording function cannot be realized.

The audio file generated by this conference system will be saved in wav format, which allows direct playing on most computers.



The system supports "Automatic recording" and "Manual recording" modes. On the recording interface as shown above, the user may touch the desired recording mode to select it.

- Automatic recording: If the automatic recording function is selected, the recording will start when any speech is delivered via any conference unit, and it will automatically stop when the last speaking unit is off. The recording may stop if there is not enough space on the USB flash disk.
- Manual recording: If manual recording is selected, the user may start recording by pressing the "Start" button and stop it by pressing the "Stop" button. Under manual recording mode, the recording will also automatically stop if there is not enough space on the USB flash disk.
- On the recording interface, the user may view the time length of recording, the file name of recorded files and the time kept on the USB flash disk.
- Composition of file name:

By default, the file is named by the starting date and time of the recording in wav format; for example if the recording starts at 12:30:50 of August 1st, then the audio file will be named as 08_01_12.30.50.wav. A new audio file will be generated when the recording is longer than 1 hour.

4.2 System Configuration

On the main interface, the user can press the "System Setup" icon and then input the password (the default password is 111111 and may be changed by the user) and press the "OK" button to enter the "System Setup" interface, which is as shown below:

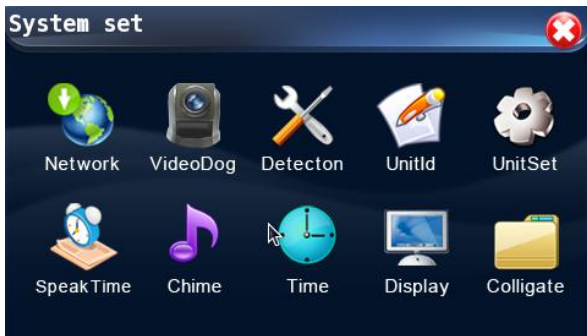

The functions provided on the system setup interface include:

- "Network Setup"
- "Camera Tracking and Positioning"
- "Unit Inspection"
- "Unit ID"
- "Unit Setup"
- "Time Limit for Speeches"
- "Microphone On/Off tone"
- "System Time"
- "Display"
- "General"

4.2.1 Network setting

The Network setup includes "IP address", "Subnet mask" and "Gateway" settings of the host controller.



- Assign a unique IP address to the conference controller. Touch the boxes after the "IP Address" and the cursor starts to blink, at this time, the user may touch the "Modify" button to call the "IP Address modification" interface, in order to modify the IP address. The interface is as shown below:

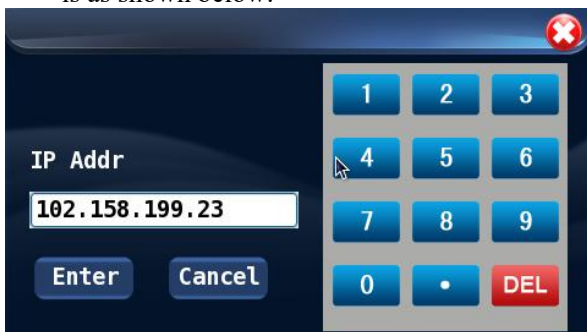

Move the input cursor behind the number you want to change, touch the red "DEL" button to delete the original number, and then use the numeric keypad to enter the target number, touch the "OK" button to confirm and exit the input interface. The procedures for setting up the subnet mask same as those of IP address.

- The method of setting the subnet mask and gateway is the same as the IP address setting.
- After all the settings are completed, the interface will automatically pop up a message saying "requiring system restart to take effect." Then restart the system.

4.2.2 Camera Tracking and Positioning

The user may touch the "Camera Positioning" icon on the "System Setup" interface to enter the camera tracking and positioning setup interface, which is as shown below:

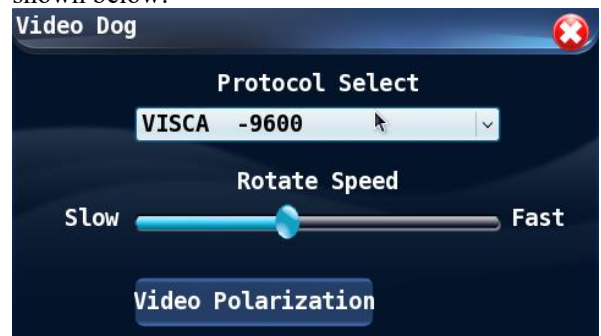

On this interface, the user may select the desired communication protocol of cameras and can set up the swing speed of cameras and can enter the camera positioning interface for further operation.

Tips: No speech will be delivered on the conference units during the setup period of camera tracking and positioning functions.

- Communication protocol: D62 series smart digital conference system provides three options: PELCO D -9600, PELCO P -9600 and VISCA -9600. In order to select the desired option, the user can touch the black arrow after the protocol box to open the drop-down list, and then touch the target communication protocol in the list to complete the whole operation. The communication protocol may vary from cameras of different brands, therefore, all the four cameras connected to the controller must be products of the same brand.
- Swing speed of camera: With this option, the user can set up the step size when the camera swings. Larger step size means faster swing speed, and the swing range will be larger,

otherwise smaller step size means slower swing speed, and the swing range will be smaller. But slower swing speed will result in better positioning precision. In order to set up the swing speed, the user may only need to slide the block to the desired position to complete the setup process.

- Camera positioning: The user may touch the "Camera Positioning" button on the graphic interface to enter the setup interface, which is as shown below:



On this interface, the user may point a camera to a particular conference unit, and the setting will be saved for future use. With this interface, the user may set up 32 conference units which will be tracked by the cameras and save 32 camera positioning plans.

To set up the camera positioning, the user should select a camera (Camera 1# for example) and then modify the conference unit ID which will be tracked by the camera (The Unit ID should be the ID of conference unit to be tracked). The user may enter the desired unit ID (for example the unit ID is 0001), via a number keyboard, on the interface shown below, and then the user may use the



button to adjust the position and focal length when the camera is pointed to such conference unit;

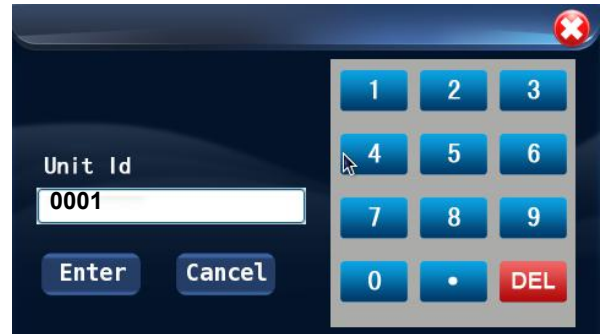

Finally, the user should save the position information of cameras. He/she can touch the "Modify" button after the "Save as preset point" to enter the modification interface. Then he/she can touch the preset points (for example "1") and then touch the "Select" button to complete the operation and exit the interface. If after the user selects a preset point, he/she touch the "DEL" button, then the position information saved on such preset point will be deleted and the preset point will be in an idle status. Preset points without position information are also in idle status.

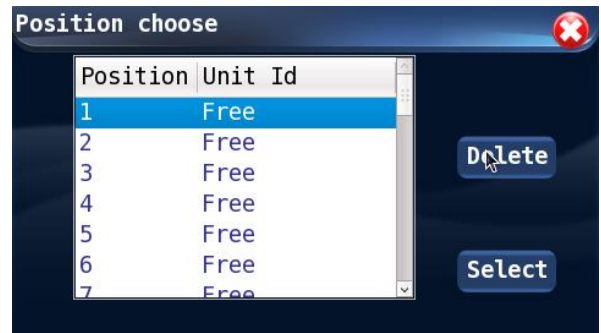

After modification to the preset points, the user can touch "Save" button to save the position information, and in future application, the user may touch the "Call" button to call the saved position plans. In each time, the system will call the preset point after the "saved preset point" (for example, the number box will display "2").

4.2.3 Microphone unit detection

On the "System Setup" interface, the user can touch the "Unit Inspection" icon to enter the unit inspection interface. The interface is as shown below:

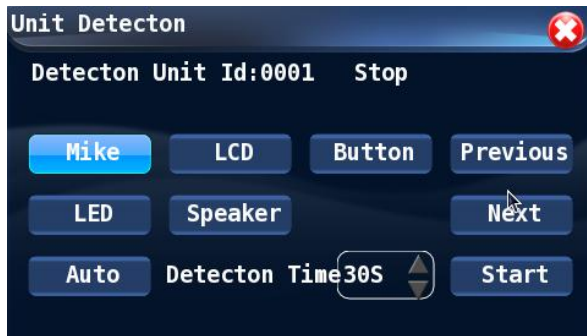

Before the conference commences, it is necessary to inspect every conference units. The items to be inspected include: "microphone, LCD screen, operation buttons, LED indicating lights and speaker". Inspection may be done manually or automatically and the inspection time is also adjustable. The inspection will be carried out on the conference units currently displayed, and the ID of such units will be displayed on the upper left corner of the interface.

Procedures for automatic inspection:

- Touch the "Automatic Inspection" button and the button is selected if it is highlighted.
- Set the "Unit inspection time", which will be effective in automatic inspection. The time may be 20-100 seconds. Touch the small arrows  after the "Unit inspection time" to adjust the time. After the inspection time is set up, the system will automatically inspect all inspection items of a conference unit, including "microphone, LCD Screen, buttons, LED lights and speaker". After the inspection on one conference unit is completed, the system will automatically proceed with the next one.
- In order to stop the automatic inspection, please touch the "Stop inspection" button.

Tips: No speech will be delivered on the conference units during inspection to the conference units.

Procedures for manual inspection:

1) Inspection to microphone

- Touch the "Inspect the microphone" button (the button is selected when it is highlighted in light blue color);
- Touch the "Start Inspection" button to inspect if the microphone can be activated and deactivated normally. During the inspection, the LED on power button and surrounding the microphone will be on and messages of "Inspecting" will be displayed on the inspection interface and the "Start inspection" button will change to "Stop inspection". Message of "Microphone is being inspected..." will be displayed on the LCD screen of the conference unit.
- After the selected conference unit is inspected,

the user can touch the "Stop inspection" button to stop the inspection and the LED lights on the conference unit inspected will be off. Or otherwise, the user may touch the "Previous Unit" or "Next Unit" to inspect other conference units connected to the conference controller and stop the inspection after all conference units are inspected.

2) Inspection to LCD screen

- Touch the "Inspection to LCD Screen" button and the button is selected if it is highlighted.
- Touch the "Start inspection" button to inspect the LCD screen of the selected unit.
- Touch the "Previous Unit" or "Next Unit" to inspect other conference units connected to the controller.

3) Inspection to buttons

- Touch the "Inspection to Buttons" button and the button is selected if it is highlighted.
- Touch the "Start inspection" button to enter unit button inspection status, and then the user should press the buttons on each conference unit to see if they work properly. When the user press a function button, if the corresponding indicating light is on and then is automatically off, it means that the button can work properly.
- After inspection to all buttons, the user should touch the "Stop inspection" button to stop the inspection, or he/she can touch other inspection item to continue with the inspection.

4) Inspection to LED indicating light

- Touch the "Inspection to LED" button and the button is selected if it is highlighted.
- Touch the "Start inspection" button to enter Unit LED inspection status, and then all LED indicating lights on the conference units being inspected will blink.
- The user may touch the "Stop inspection" button to stop the inspection, or he/she can touch other inspection item to continue with the inspection.

5) Inspection to speaker

- Touch the "Inspection to speaker" button and the button is selected if it is highlighted.
- Touch the "Start inspection" button to enter the unit speaker inspection status, and the speakers of conference units being inspected will beep, this means that the speaker can work properly.
- The user may touch the "Stop inspection" button to stop the inspection, or he/she can touch other inspection item to continue with the inspection.

After all inspection items are completed, the user should touch the  icon to exit the inspection

interface.

4.2.4 Microphone unit set ID

Touch the "Unit numbering" button on the "System setup" interface to enter the unit numbering interface which is as shown below:

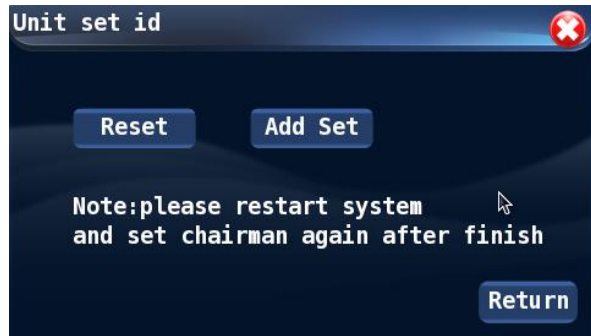

On this interface, the user can renumber all the existing conference units and number the newly connected units.

1) Renumbering

- On the "Unit Numbering" interface, the user can touch the "Renumber" button to enter the renumbering interface which is as shown below:

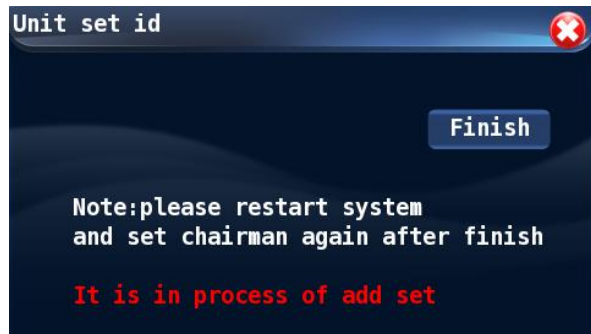

- On the interface shown above, the user should set up the unit ID on the conference units to be renumbered (please refer to the description on conference setup section for information with respect to unit numbering operations). After the operation has completed, the user should touch the "End" button as shown above, to exit the interface.
- After all conference units are numbered, the unit IDs renumbered will take effect after the conference controller is power off and restarted.

2) Add new ID

- On the "Unit Numbering" interface, the user can touch the "Add new ID" button to enter the operation interface which is as shown below:

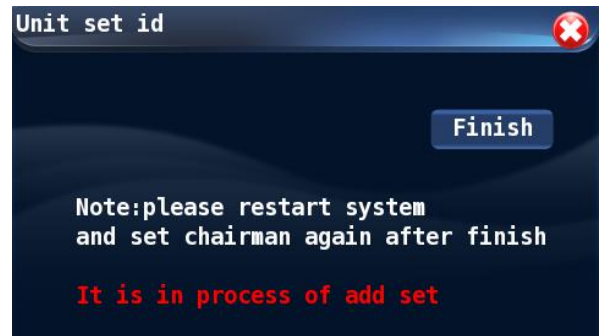

- The user should set up the IDs on newly added conference units and after the setup operation, he/she should touch the "END" button on the interface shown above to exit the interface.
- After all new conference units are numbered, the newly added unit IDs will take effect after the conference controller is power off and restarted.

After the conference units are numbered, the user may touch the  icon on the upper right corner of the "Unit Numbering" interface to exit the numbering interface.

Tips: After the conference units are renumbered, the camera tracking information and the chairman unit assigned will be deleted, so the user needs to reset them.

4.2.5 Conference microphone setting

Touch the "Unit Setup" button on the "System setup" interface to enter the unit setup interface which is as shown below:



On the unit setup interface, the following setup operations are available:

- "Chairman unit 1"
- "Chairman unit 2"
- "Platform mode"
- "Priority"
- "Vote result display"
- "Setting of VIP units"

1) Chairman unit

D62 series smart digital conference system allows 2

chairman units which are given the priority to make speeches, and they can operate simultaneously. The setup procedures are as follows:

- On the "Unit Setup" interface, touch and select the "Chairman Unit" (for example, Chairman Unit 1 is selected). When an option is selected, the  icon before such option will be displayed in green color.
- Touch the black arrow after the ID box of conference unit to unfold the drop-down list, and select the ID from the menu for "Chairman Unit 1" or "Chairman Unit 2".
- After all conference units are numbered and the conference system is restarted, the Chairman Units will be automatically identified and its ID will be displayed in the list on the operation interface.
- The ID of conference unit set as a Chairman unit will be displayed on the following interface.



If ten chairman units are connected to the system, then after all conference units are renumbered, all the ten chairman units will be identified by the conference controller and will be displayed on the list as shown above.

2) Platform mode

- To set up the platform on/off status of Chairman Unit 1 and Chairman Unit 2, the user may simply touch the desired option to complete the setup operation.
- If the Platform mode is "ON", then both the two chairman units will be always on and the ON/OFF button the chairmen unit will be ineffective; if the platform is "OFF", the chairman unit will be operated by the On/Off button on such units.

3) Priority

- The user may set the priority of Chairman Unit 1 and Chairman Unit 2 as "Mute" or "Off". The user may touch the options after "Priority" on this interface to complete the setup.
- If "Mute" is selected, then in the conference, when the chairman presses the priority button,

then all activated conventioner unit will be turned to mute status. After the activated conventioner unit is mute, the On/Off LED light on the microphone will blink, and a sound off message will be displayed on LCD screens of the Chairman unit and the conventioner units. Please refer to the description of conference unit setup section for detailed information as the content displayed and the operation instructions. If it is no longer necessary to turn off the microphones of conventioner units, they chairman may press the priority button and cancel the sound off status by following the instructions on the LCD screen, the conventioner unit will be able to deliver speeches.

- If "Off" is selected, then in the conference, when the chairman presses the priority button, then all activated conventioner unit will be turned off.

4) Vote result display (Only effective on units with LCD screen)

- With this option, the user may decide if the vote result will be displayed on all conference units including the Chairman Unit 1 and Chairman Unit 2. The user may touch the options after "Vote Result Display" button to complete the setup.
- If "YES" is selected, then the vote result will be displayed on all conference units; of "NO" is selected, then the vote results will not be displayed on LCD screens of any conference unit other than the chairman unit 1 and 2.

5) Setting of VIP units

The user may touch the "VIP Unit Setup" button on the "Unit Setup" interface to enter the VIP unit setup interface which is as shown below:

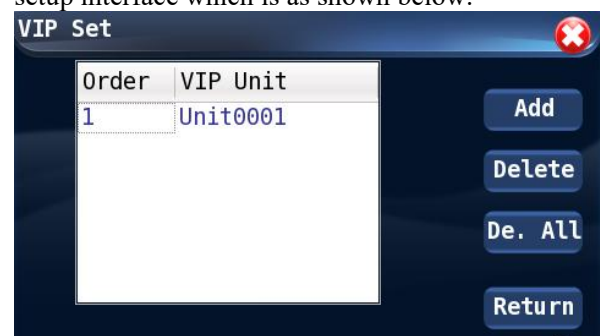

D62 series smart digital conference system allows a maximum number of 30 VIP units. The VIP unit may be a conference unit of whatever type. When the total activated conference unit is less than 20 under FREE mode and 10 under any other mode, the VIP unit is free from limitation of conference mode and may be turned on/off freely.

- On the interface shown above, the user may add new VIP units by touching the "ADD" button. The conference system allows a

maximum number of 30 VIP units. Touch the "ADD" button to enter the VIP unit operation interface:

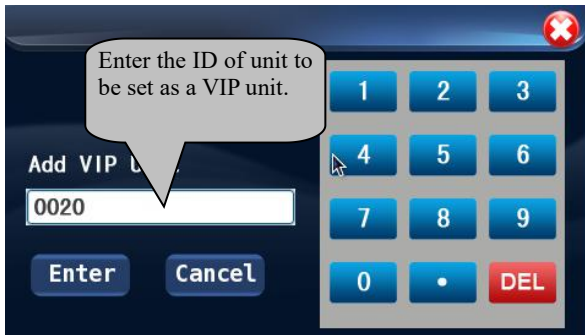

On the interface as shown above, they user may enter the ID of conference unit to be set as a VIP unit, and then touch the "OK" button to confirm and exit the interface.

- The user can touch the "DEL" button to delete the VIP unit selected.
- They user may touch the "DELETE ALL" button to delete all existing VIP units.
- With the "Return" button or by touching the  icon, the user can exit VIP setup interface and return to the unit setup interface.

After the unit setup is completed, the user may touch the  icon on the upper right corner to exit the unit setup interface and return to the main interface of the system.



4.2.6 Set speak time

The user may touch the "Timing of Speeches" button on the "System Setup" interface to enter the timing setup interface which is as shown below:



On this interface, the user can set up the time limit for speeches of conventioners and the speech unit will be automatically shut off when the time is over. The time limit can be any value between 1 and 300 minutes. D62 series digital conference system provides a countdown warning function, and the user can set up the countdown time in this interface, which should be with the range between 1 and 60 seconds. The countdown will also be displayed on the speech unit. If the speech timing function is not needed in the conference, then it can be set as "OFF".

The user can adjust the values of time limit and

countdown function to the desired value by touching the small gray arrows after the time indication  

After the time value setup is completed, the user may touch the  icon on the upper right corner to exit the setup interface and return to the main interface of the system.

4.2.7 Chime set

The user may touch the "Ring tone" icon on the "System Setup" interface to enter the ring tone setup interface which is as shown below:

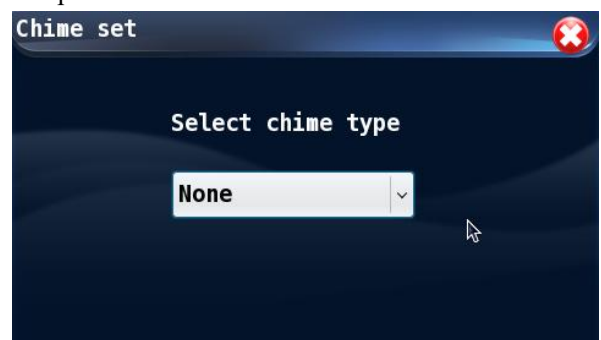

Select the prompt tone when the microphone is turned on or off. The options available for setup includes:

- "No ring tone"
- "Ring tone 1"
- "Ring tone 2"
- "Ring tone 3"

1) "No ring tone" means that there is no indicating sound when the microphone of conference unit is powered on or off.

2) "Ring tone 1- Ring tone 3" indicates that one of the ring tones will be played when the microphone on the conference unit is turned on/off.

4.2.8 Set system time

The user may touch the "Time" icon on the "System Setup" interface to enter the system time setup interface which is as shown below:

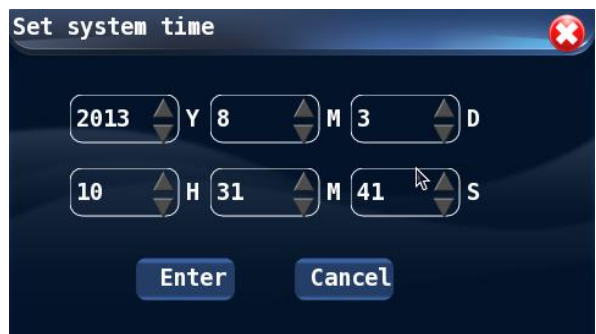

The current system time can be adjusted on this interface. The system time set here is displayed on the top edge of the main interface.

- 1) To set the system time, the user can touch the gray arrows respectively after the values of Year, Month, Data, Hour, Minute and Second to adjust the system time.
- 2) After the setup is completed, the user should touch the "OK" button to confirm and exit the system time setup interface.

4.2.9 Display setting

The user can touch the "Display" icon on the "System Setup" interface to enter the conference controller LCD screen setup interface. The options available for setup include:

- "Backlight on time"
- "Touch screen calibration"

1) Backlight on time

This is the time or status set for the backlight of LCD screen on the conference controller.

- After the user sets up the backlight times, if there is no operation on the equipment within such period of time, the back light of LCD screen will be off and it will be on again if any operation is made on the equipment, so that it helps to save energy and to extend the service life of LCD screen. The backlight time may be any value between 1 and 240 minutes.
- If the backlight is set as "Always On", then the backlight will be on for the period after the equipment is powered on and before it is powered off.

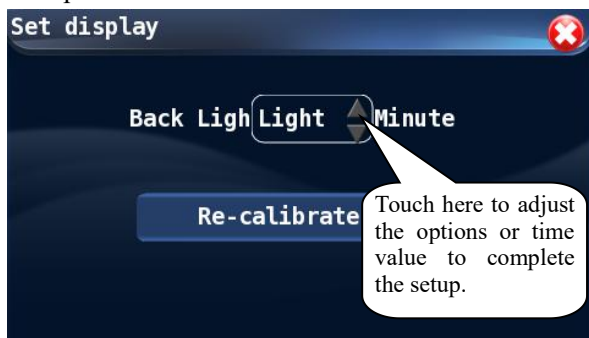

- The user can touch the gray arrows after the "backlight time" to adjust the option or backlight time.

2) Touch screen calibration

After the equipment is used for a certain period, due to the rise of temperature or other factors, the touch point is not precise and it may be hard to move the touch point to the desired operation item, at such time, the user needs to calibrate the touch screen by following the following procedures:

- Touch the "Screen Calibration" button on the "Display Setup" interface to enter the screen

calibration interface.

- After the touch screen is in the calibration status, the system will automatically restart and enter the screen calibration interface after a while.
- On the calibration interface, the user should touch the center of the small circle on the screen with the sharp end of the pen (Note: Touch the exact center of the circle).
- Repeat the calibration on all four corners and the center of the touch screen, otherwise, it will be hard to move the cursor to the desired option. In such cases, the user can connect a USB mouse to the system to enter the touch screen calibration interface, in order to restart the system and complete the calibration. Or otherwise, the user may also operate the system by using the mouse.

Notice:

During touch screen calibration, it is very important to point the pen to the center of the "+", otherwise the user may not be able to operate the system. The touch pen should be used to operate the touch screen during the calibration, which helps to reduce the chances of misoperation.

4.2.10 General setting

The user may touch the "General" icon on the "System Setup" interface to enter the general setup interface which is as shown below:



The options on the general setup interface includes:

- "Language"
- "Export configuration file to USB flash disk"
- "Import configuration file to the system"
- "Modify the Password on the Equipment"
- "Machine Code of this Equipment"

1) Language selection

With this option, the user can setup the display language for the system. The conference system supports Chinese and English languages. Touch the small arrow after the language bar to open

the drop-down menu, and then touch the desired option. Then close the setup interface and return to the main interface.

2) "Export configuration file to USB flash disk"

- With this conference system, the user can back up the system to or restore the system from a USB flash disk. Before the export operation, please make sure that a USB flash disk has been connected to the USB port of the controller, otherwise the system will prompt: "No USB flash disk found, please check".
- Touch the "Export configuration file to USB flash disk" to complete the exportation operation. A dialog will show in the interface, indicating that the exportation operation has been successfully completed.

3) Import configuration file to the system

- With this operation, the user can restore backup system parameters to the conference controller system, in order to restore such parameters. Before the import operation, please make sure that a USB flash disk has been connected to the USB port of the controller, otherwise the system will prompt: "No USB flash disk found, please check".
- Touch the "Import configuration file to the system", and then touch the "OK" button in the dialog box to copy the configuration file to the system. After the configuration file is copied to the system, the system will be restarted automatically in order to load the system parameters restored.

4) Modify the password on the equipment

The user can touch the "Modify the password" button on the "General Setup" interface to enter the password modification interface which is as shown below:

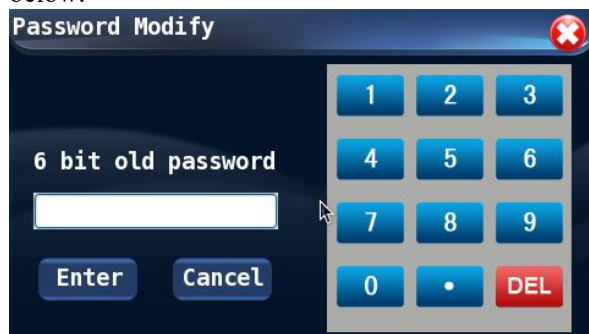

- The user may set a password for accessing the "System Setup" interface.
- To modify the password, the user need to input the current password, which is 111111 by

default, and then touch the "OK" button to enter the new password and confirm the password by input such new password again. The new password will take effect after the user reconfirms such password.

- Every time when the user attempts to enter the "System Setup" interface, he/she should enter the password, so it is strongly recommended to remember the password.

5) Machine Code of this Equipment

On this interface, the user can view the machine code, which is set when the equipment is delivered from the manufacturing factory. Each equipment has a unique machine code.

4.3 Extension host address encoding setting

D62 series digital conference system has very good extensibility scalability. In the system up to 32 extension controllers may be connected to the conference controller, and with such extension controllers, the whole system may have 4096 conference units. In order to tell the controllers from one another, it is necessary to assign a unique address code (ID code) to each extension controller.

The address code of a extension controller is on the rear panel of such controller, which is realized by 8 bit ID DIP switches. The system connection is as follows:

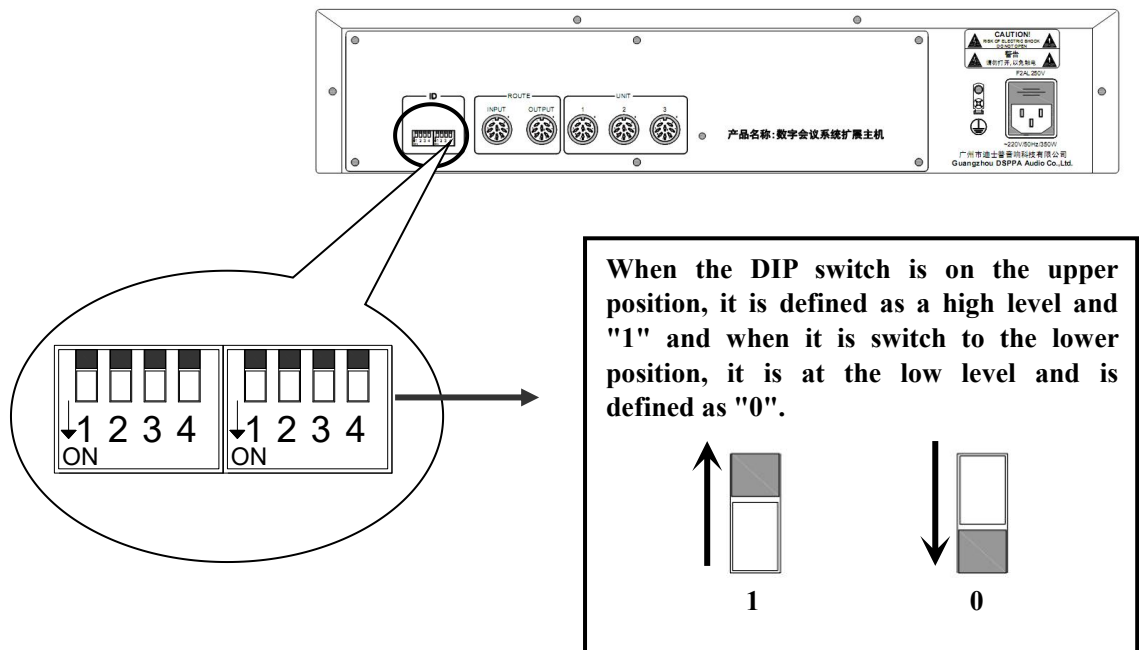

For example, the ID code of the first extension controller is set as 0000 0000, then all such DIP are switched to the lower position; the ID code of the second controller is 0000 0001, then the last DIP is at the high level while all others are at the lower position. The setting on the rear panel of extension controller is as shown below. Please refer to the List of Extension Controller IDs for information with respect to the setup of other extension controllers.

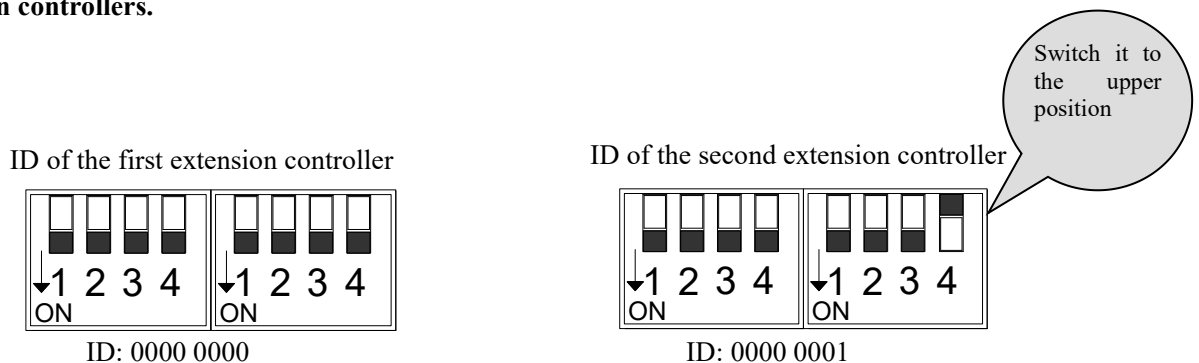

List of Extension Controller ID

Equipment ID	ID	Equipment ID	ID
1#	0000 0000	27#	0001 0000
2#	0000 0001	28#	0001 0001
3#	0000 0010	19#	0001 0010
4#	0000 0011	20#	0001 0011
5#	0000 0100	21#	0001 0100
6#	0000 0101	22#	0001 0101
7#	0000 0110	23#	0001 0110
8#	0000 0111	24#	0001 0111
9#	0000 1000	25#	0001 1000
10#	0000 1001	26#	0001 1001
11#	0000 1010	27#	0001 1010
12#	0000 1011	28#	0001 1011
13#	0000 1100	29#	0001 1100
14#	0000 1101	30#	0001 1101
15#	0000 1110	31#	0001 1110
16#	0000 1111	32#	0001 1111

4.4 Host fuse handling method

If the fuse is blown, please replace it with fuse of the same specification. Please refer to the information printed under the power socket for information as to the specifications of fuse; or the user may refer to the "Power supply protection" section of the "Performance and specification -- General" on the User's Manual for information; or otherwise, the user may remove the blown fuse to check its specification.

The position of the fuses is as indicated on the picture below:

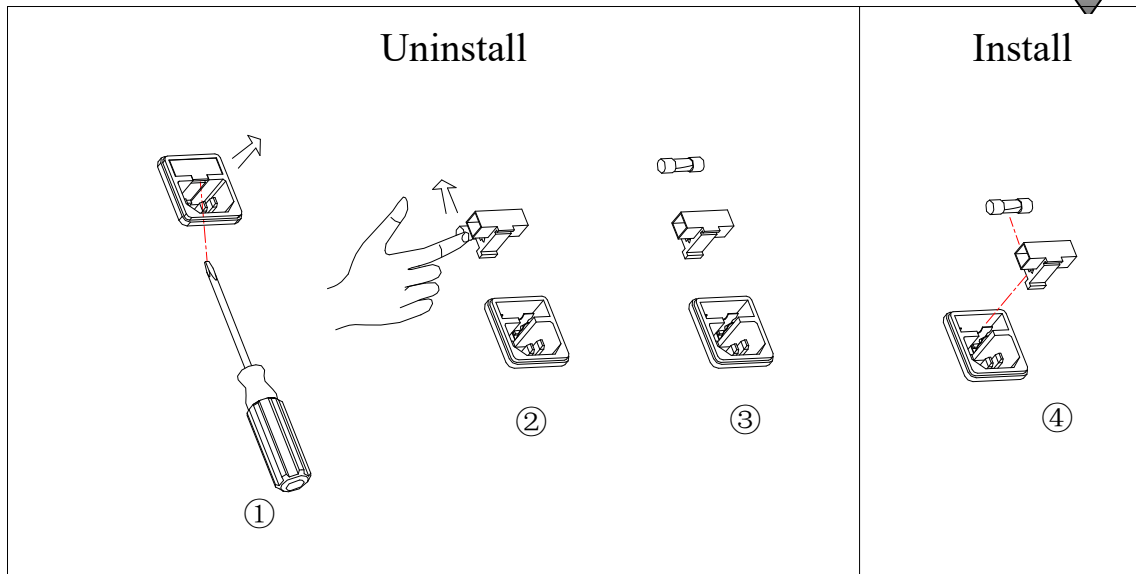
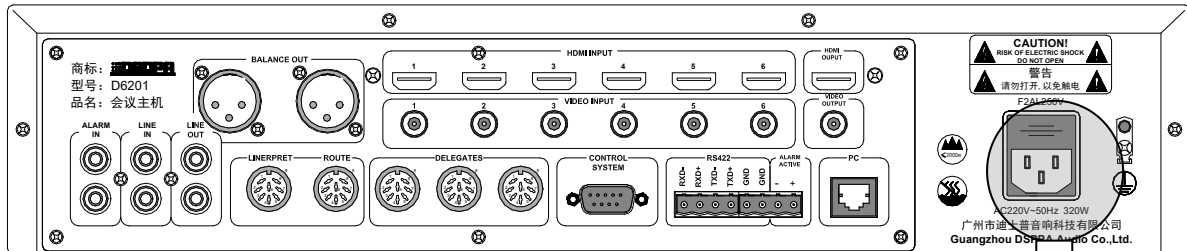

Procedures for replacement of fuses:

1. Before the fuse is replaced, please cut off the power supply and unplug the equipment from the socket.
2. As shown by Fig. ①, a straight screwdriver should be used to remove the fuse.
3. Remove the fuse from the holder and check if it is blown and its specification.
4. Install a fuse of the same specification back to the holder in accordance with the instructions shown on Fig. ④.

Note: When the fuse is pushed into the holder, there is a clicking noise which indicates that the fuse is in its position.

Safety Precautions

1. Safety Precautions

- Please do NOT connect this device to the power source, before the system is correctly wired.
- It is important to ensure that input voltage to the device is the same as required voltage of the device, otherwise the device may be damaged.
- There is dangerous voltage in the device, which may cause personal electric shock. Please do NOT open the case without permission, to avoid potential risks of electric shock.
- The device is not completely disconnected from power source when it is switched "OFF". For sake of safety, please disconnect the device from the socket if it is not in use.
- Please do NOT place the device where it is extremely cold or hot.
- Good ventilation must be provided in the working environment of the device, to avoid excessive temperature during its operation, which may cause damages to the device.
- Please unplug the device from power socket in raining and wet days or if the device is not in use for a long time.
- Please disconnect the power plug from sockets, to ensure the device has been completely disconnected from power source, before any component is removed from or re-installed in the device or before any electric connector of the device is disconnected or reconnected.
- In case of any failure of the device, please do NOT open the case and repair without permission from a professional personnel, to avoid accident or additional damages to the device.
- Please do NOT place any corrosive chemicals near or on the device.

2. Matters needing attention

- Our company provides a three-year free warranty service (including free replacement parts) over quality issues as from the date of purchase, provided that the device is installed and used in accordance with requirements specified in the User Manual.
- For warranty, the user must show the Warranty Card and the receipt kept by the user and purchase invoice of the device as supporting documents.
- The following conditions are beyond the scope of warranty:
 1. Product damage due to improper installation, use or handling;
 2. Product damage due to abnormal conditions (such as excessive power source voltage or ambient humidity);
 3. Product damage due to acts of God;
 4. Product SN is changed, altered or removed;
 5. Product has been repaired or modified by any person without duly authorization from our company;
- Please keep the User Manual and Warranty Card in good custody.
- For issues and precautions not mentioned in this User Manual, if required, please contact the distributor or visit our website at <http://www.DSPPA.com>.
- In case of any failure in the warranty period, please contact service personnel (or distributor) of our company for service. The company shall not be made liable for damages due to unauthorized dis-assembly or maintenance or service by unauthorized personnel.

Packing list

No	Name	QTY
1	D6201 conference host	1 PC
2	10A national standard MP-P power cable	1 PC
3	5×19 Half countersunk head cross wire (silver white)	4 PCS
4	SY542 1.5m audio cable	1 PC
5	4P green head	2 PC
6	EVA Foot mat (black)	4 PCS
7	Washer (black)	4 PCS
8	Certificate of Approval	1 PC
9	Warranty card	1 PC
10	Manual	1 PC

Parameters

Item	D6201
LINE input voltage	250 (±30) mV
ALARM input voltage	250 (±30) mV
LINE output voltage	1 (±0.1) V
BALANCE output voltage	1 (±0.1) V
Frequency response	40Hz-20kHz (-3dB)
Maximum input voltage	4 (±0.2) V
SNR	>80 dB
Harmonic distortion	<0.3%
Output power	≤110W/3-way, 24V
Max. power	320W
Static power consumption	15W
Quantity of maximum units	128 ps
Control interface	RJ45, RS232, RS422
Power source	Switch Mode Power Supply 220V-240V/50Hz/320W
Net Weight	6.9kg
Dimension	484×385×88 mm
Item	Index parameters

Note: The performance specifications are subject to changes without further notification.

Caution

- The device is not completely disconnected from power source when it is switched "OFF". For sake of safety, please disconnect the device from the socket if it is not in use.
- Please keep this device off water drops or splash or vase filled with water or any other articles of similar nature.
- Please do NOT remove the cover of the equipment, otherwise you may get an electric shock. Where necessary, repair to the equipment should be conducted by qualified professionals.
- All terminals on the device marked with ⚡ are live and dangerous, and should be connected by trained personnel.
- This is connected to power source via the plug and any failure or danger occurs, the user can disconnect the device from power source by pulling out the plug out from the socket, therefore, it is required that the power socket should be located somewhere with easy access.

Guangzhou DSPPA Audio Co., Ltd.

注意：此页不打印

广州市迪士普音响科技有限公司			
型号名称	D6201会议控制主机说明书（3C认证）		
内容修改	修改说明书中的“非热带气候条件下安全使用”标志		
版本	V0.6	审核：	
编制	王小胜	批准：	
日期：	2018.5.23		